

FS6S1265RE

Fairchild Power Switch(FPS)

Features

- Wide Operating Frequency Range Up to 150kHz
- Lowest Cost SMPS Solution
- Lowest External Components
- Low Start up Current (Max:170uA)
- Low Operating Current (Max:15mA)
- Internal High Voltage SenseFET
- Built-in Auto Restart Circuit
- Over Voltage Protection (Auto Restart Mode)
- Over Load Protection (Auto Restart Mode)
- Over Current Protection (Auto Restart Mode)
- Internal Thermal Protection (Auto Restart Mode)
- Pulse By Pulse Over Current Limiting
- Internal Burst Mode Controller for Stand-by Mode
- Under Voltage Lockout With Hysteresis
- External Sync. Terminal

Description

The Fairchild Power Switch(FPS) product family is specially designed for an off line SMPS with minimal external components. The Fairchild Power Switch(FPS) consist of high voltage power SenseFET and current mode PWM IC. Included PWM controller features integrated fixed oscillator, under voltage lock out, optimized gate turn on/turn off driver, thermal shut down protection, over voltage protection, and temperature compensated precision current sources for loop compensation and fault protection circuitry. compared to discrete MOSFET and controller or RCC switching converter solution, a Fairchild Power Switch(FPS) can reduce total component count, design size, and weight and at the same time increase efficiency, productivity, and system reliability. It has a basic platform well suited for cost effective monitor power supply.

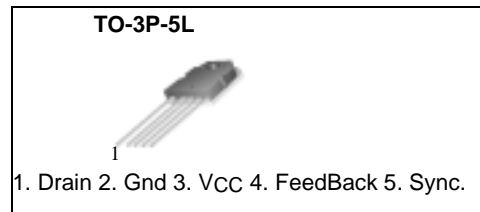

Internal Block Diagram

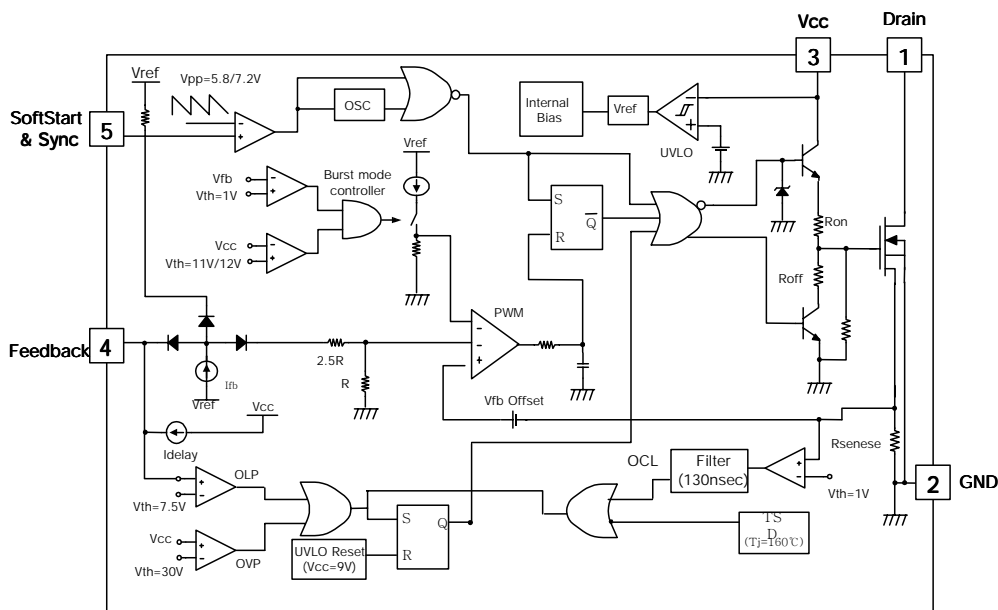

Absolute Maximum Ratings

(Ta=25°C, unless otherwise specified)

Characteristic	Symbol	Value	Unit
Drain-Gate Voltage(R _{GS} =1MΩ)	V _{DGR}	650	V
Gate-Source(GND) Voltage	V _{GS}	±30	V
Drain Current Pulsed ⁽¹⁾	I _{DM}	48	ADC
Continuous Drain Current (T _c = 25°C)	I _D	12	ADC
Continuous Drain Current (T _c = 100°C)	I _D	8.4	ADC
Single Pulsed Avalanche Current ⁽³⁾ (Energy ⁽²⁾)	I _{AS} (EAS)	30(950)	A(mJ)
Maximum Supply Voltage	V _{CC,MAX}	35	V
Input Voltage Range	V _{FB}	-0.3 to V _{CC}	V
	V _{SS}	-0.3 to 10	V
Total Power Dissipation	P _D (Watt H/S)	240	W
	Darting	1.92	W/°C
Operating Junction Temperature.	T _J	+150	°C
Operating Ambient Temperature.	T _A	-25 to +85	°C
Storage Temperature Range.	T _{STG}	-55 to +150	°C

Note:

1. Repetitive rating: pulse width limited by maximum junction temperature
2. L = 10mH, starting T_j = 25°C
3. L = 13uH, starting T_j = 25°C

Electrical Characteristics (SFET Part)

(Ta = 25°C unless otherwise specified)

Parameter	Symbol	Conditions	Min.	Typ.	Max.	Unit
Drain-Source Breakdown Voltage	BVDSS	VGS = 0V, ID = 50μA	650	-	-	V
Zero Gate Voltage Drain Current	IDSS	VDS=Max, Rating, VGS = 0V	-	-	200	μA
		VDS= 0.8Max, Rating, VGS = 0V, TC = 125°C	-	-	300	μA
Static Drain-Source on Resistance ⁽¹⁾	RDS(on)	VGS = 10V, ID = 4.5A	-	0.7	0.9	Ω
Forward Transconductance ⁽²⁾	gfs	VDS = 50V, ID = 4.5A	-	-	-	S
Input Capacitance	Ciss	VGS = 0V, VDS = 25V, f = 1MHz	-	1820	-	pF
Output Capacitance	Coss		-	185	-	
Reverse Transfer Capacitance	Crss		-	32	-	
Turn on Delay Time	td(on)	VDD = 0.5BVDSS, ID = 12.0A (MOSFET switching time are essentially independent of operating temperature)	-	38	-	nS
Rise Time	tr		-	120	-	
Turn Off Delay Time	td(off)		-	200	-	
Fall Time	tf		-	100	-	
Total Gate Charge (Gate-Source+Gate-Drain)	Qg	VGS = 10V, ID = 12.0A, VDS = 0.5BVDSS(MOSFET Switching time are Essentially independent of Operating temperature)	-	60	-	nC
Gate-Source Charge	Qgs		-	10	-	
Gate-Drain (Miller) Charge	Qgd		-	30	-	

Note:

1. Pulse test: pulse width ≤ 300us, duty 2%

2. $S = \frac{1}{R}$

Electrical Characteristics (Control Part) (Continued)(V_{CC}=16V, T_{amb} = 25°C unless otherwise specified)

Parameter	Symbol	Conditions	Min.	Typ.	Max.	Unit
UVLO SECTION						
Start Threshold Voltage	VSTART	V _{FB} =GND	14	15	16	V
Stop Threshold Voltage	VSTOP	V _{FB} =GND	8	9	10	V
OSCILLATOR SECTION						
Initial Frequency	FOSC	-	22	25	28	kHz
Voltage Stability	FSTABLE	12V ≤ V _{CC} ≤ 23V	0	1	3	%
Temperature Stability (Note2)	ΔFOSC	-25°C ≤ T _a ≤ 85°C	0	±5	±10	%
Maximum Duty Cycle	DMAX	-	92	95	98	%
Minimum Duty Cycle	DMIN	-	-	-	0	%
FEEDBACK SECTION						
Feedback Source Current	IFB	V _{FB} =GND	0.7	0.9	1.1	mA
Shutdown Feedback Voltage	VSD	V _{FB} ≥ 6.9V	6.9	7.5	8.1	V
Shutdown Delay Current	IDELAY	V _{FB} =5V	1.6	2.0	2.4	μA
SYNC. & SOFTSTART SECTION						
Softstart Voltage	VSS	V _{FB} =2V	4.7	5.0	5.3	V
Softstart Current	ISS	V _{SS} =0V	0.8	1.0	1.2	mA
Sync High Threshold Voltage(Note3)	VSYNCH	V _{CC} =16V, V _{FB} =5V	-	7.2	-	V
Sync Low Threshold Voltage(Note3)	VSYNCL	V _{CC} =16V, V _{FB} =5V	-	5.8	-	V
BURST MODE SECTION						
Burst Mode Low Threshold Voltage	VBURL	V _{FB} =0V	10.4	11.0	11.6	V
Burst Mode High Threshold Voltage	VBURH	V _{FB} =0V	11.4	12.0	12.6	V
Burst Mode Enable Feedback Voltage	VBEN	V _{CC} =10.5V	0.7	1.0	1.3	V
Burst Mode Peak Current Limit(Note4)	IBURPK	-	0.45	0.6	0.75	A
Burst Mode Frequency	FBUR	V _{CC} =10.5V, V _{FB} =0V	40	50	60	kHz
CURRENT LIMIT(SELF-PROTECTION)SECTION						
Peak Current Limit (Note4)	I _{OVER}	-	7.04	8.0	8.96	A
PROTECTION SECTION						
Over Voltage Protection	VOVP	V _{CC} ≥ 27V	27	30	33	V
Over Current Latch voltage(Note3)	VOCL	-	0.9	1.0	1.1	V
Thermal Shutdown Temperature(Note2)	TSD	-	140	160	-	°C
TOTAL DEVICE SECTION						
Start-Up Current	I _{START}	V _{FB} = GND, V _{CC} = 14V	-	0.1	0.17	mA
Operating Supply Current(Note1)	I _{OP}	V _{FB} = GND, V _{CC} = 16V	-	10	15	mA
	I _{OP(MIN)}	V _{FB} = GND, V _{CC} = 12V				
	I _{OP(MAX)}	V _{FB} = GND, V _{CC} = 30V				

Notes:

1. These parameters are the Current Flowing in the Control IC.
2. These parameters, although guaranteed, are not 100% tested in production
3. These parameters, although guaranteed, are tested in EDS(wafer test) process
4. These parameters are indicated Inductor Current.

Typical Performance Characteristics

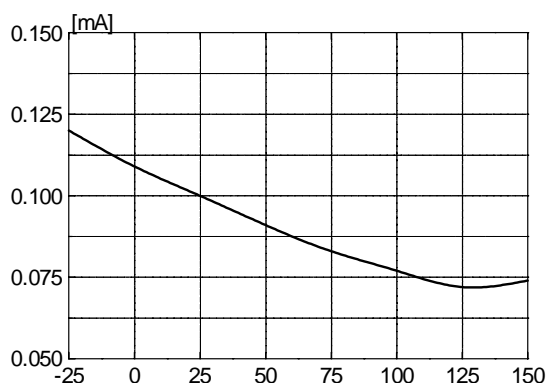

Figure 1. Start Up Current vs. Temp.

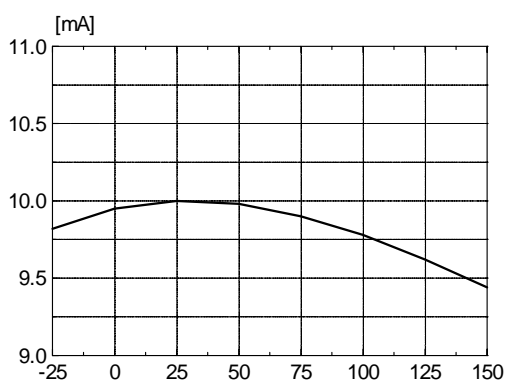

Figure 2. Operating Current vs. Temp.

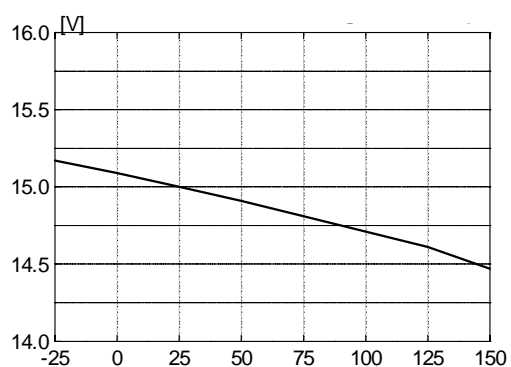

Figure 3. Start Threshold Voltage vs. Temp.

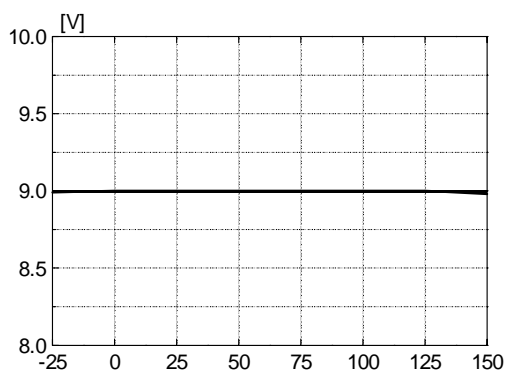

Figure 4. Stop Threshold Voltage vs. Temp.

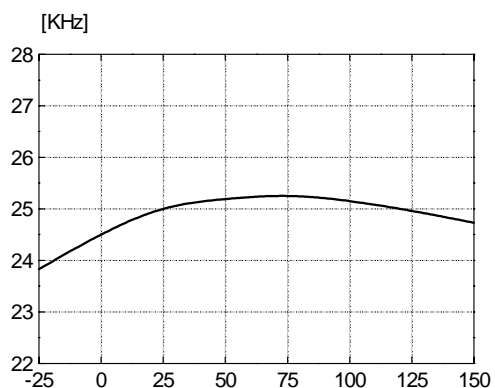

Figure 5. Initial Frequency vs. Temp.

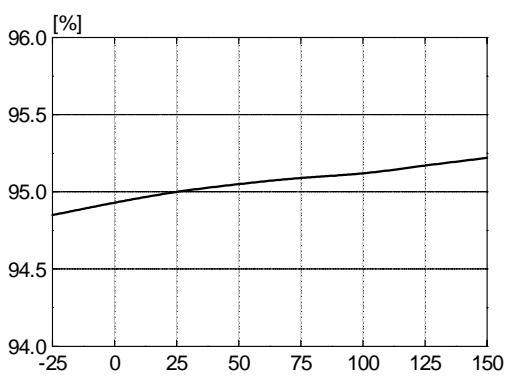

Figure 6. Maximum Duty vs. Temp.

Typical Performance Characteristics (Continued)

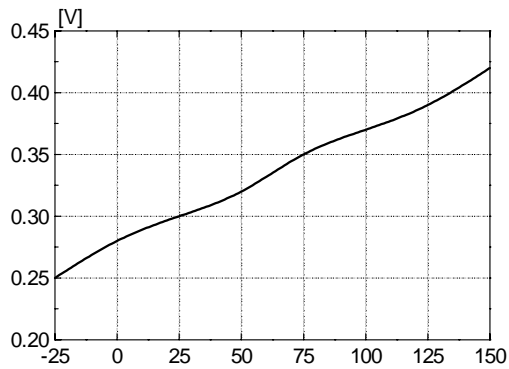

Figure 7. Feedback Offset Voltage vs. Temp.

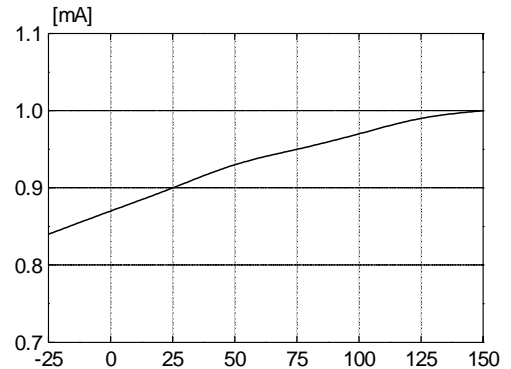

Figure 8. Feedback Source Current vs. Temp.

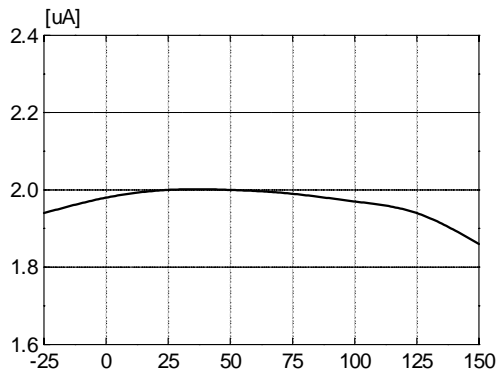

Figure 9. Shutdown Delay Current vs. Temp.

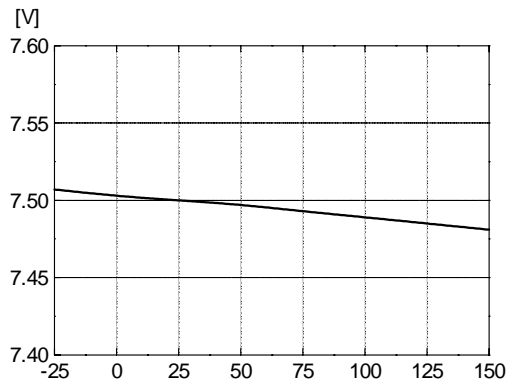

Figure 10. Shutdown Feedback Voltage vs. Temp.

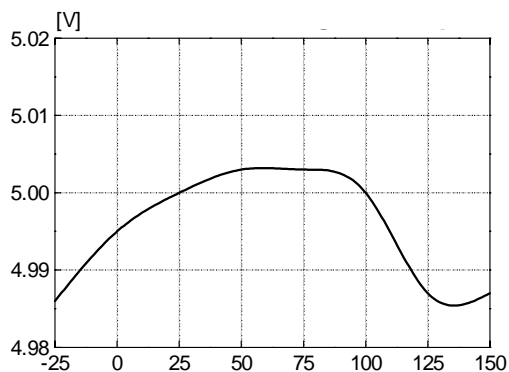

Figure 11. Softstart Voltage vs. Temp.

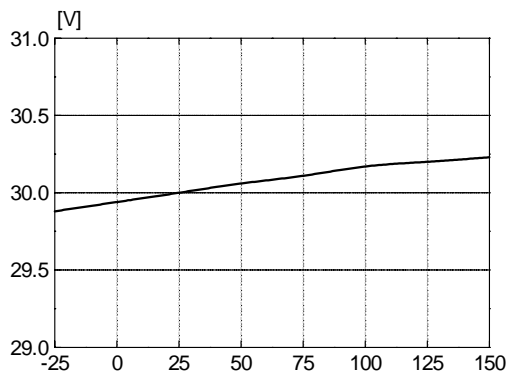

Figure 12. Over Voltage Protection vs. Temp.

Typical Performance Characteristics (Continued)

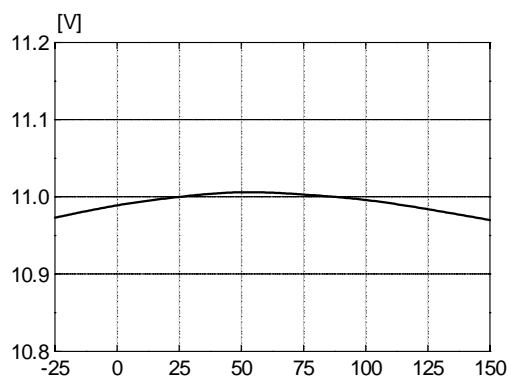

Figure 13. Burst Mode Low Voltage vs. Temp.

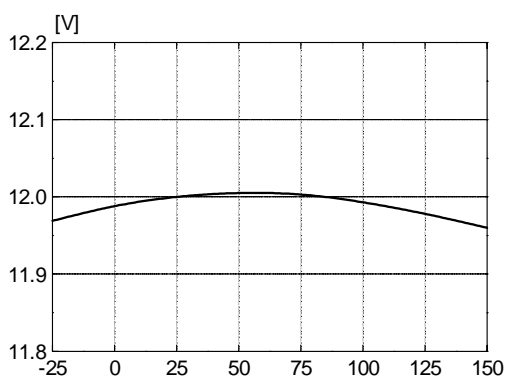

Figure 14. Burst Mode High Voltage vs. Temp.

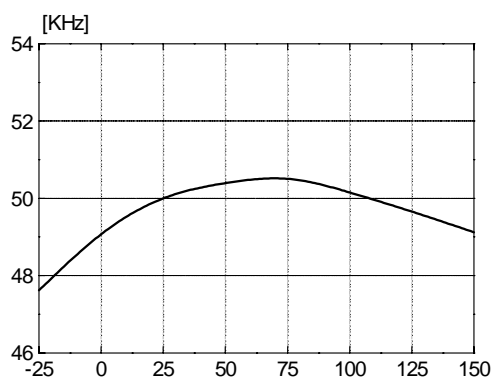

Figure 15. Burst Mode Frequency vs. Temp.

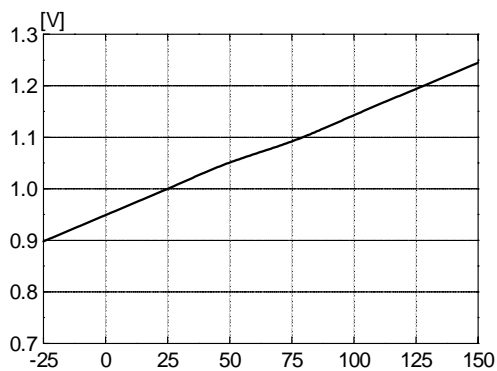

Figure 16. Burst Mode Enable Voltage vs. Temp.

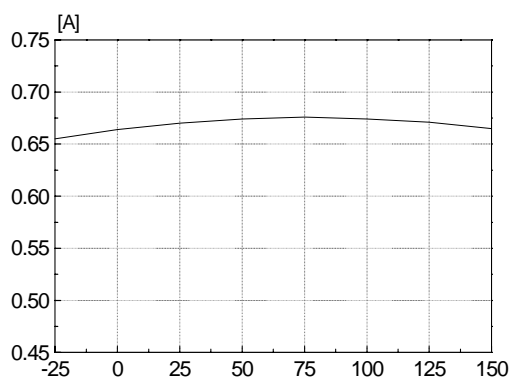

Figure 17. Burst Mode Peak Current vs. Temp.

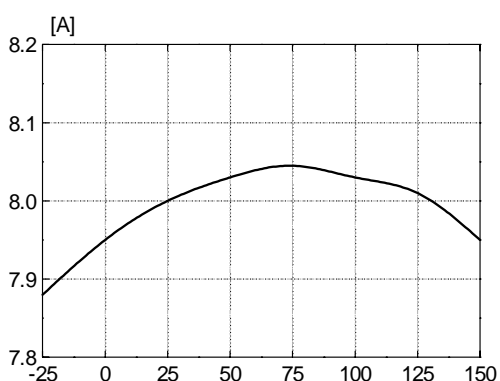
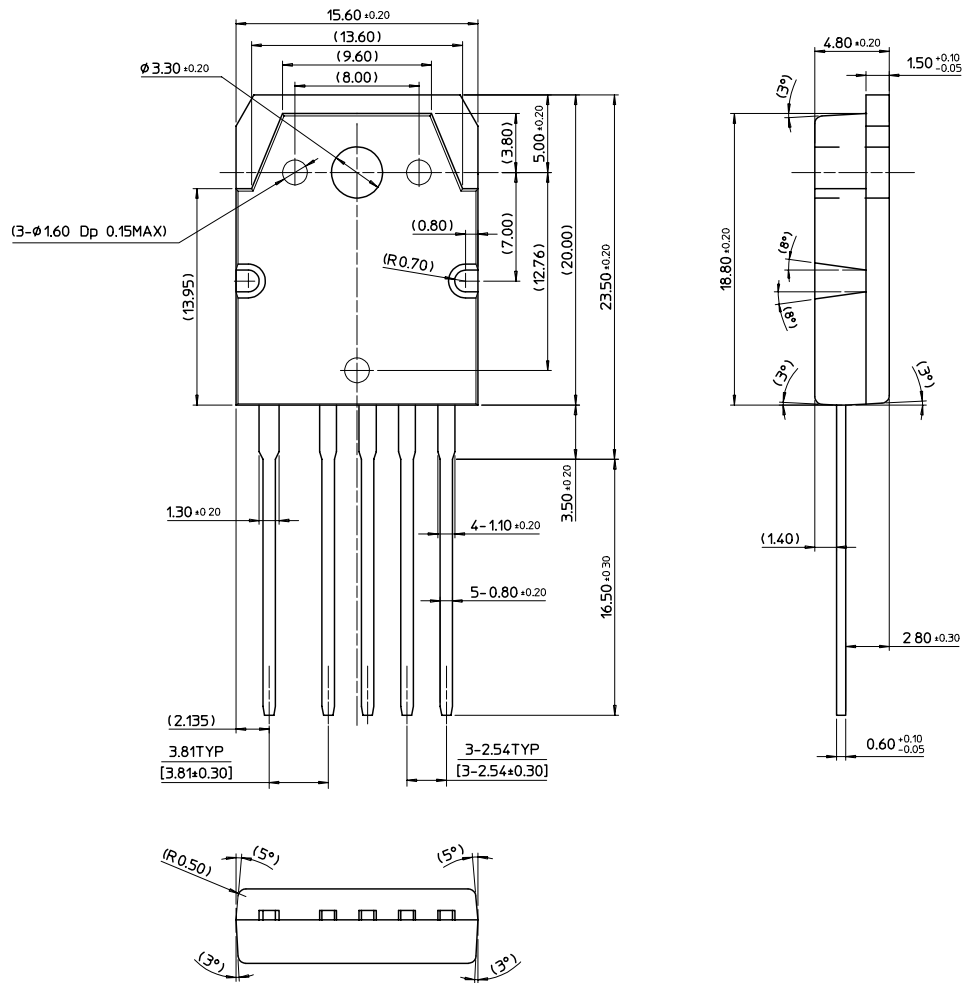

Figure 18. Peak Current Limit vs. Temp.

Package Dimensions

TO-3P-5L



Ordering Information

Product Number	Package	Marking Code	BVdss	Rds(on)
FS6S1265RETU	TO-3P-5L	6S1265R E	650V	0.7Ω
FS6S1265REYDTU	TO-3P-5L(Forming)			

TU : Non Forming Type

YDTU : Forming Type

DISCLAIMER

FAIRCHILD SEMICONDUCTOR RESERVES THE RIGHT TO MAKE CHANGES WITHOUT FURTHER NOTICE TO ANY PRODUCTS HEREIN TO IMPROVE RELIABILITY, FUNCTION OR DESIGN. FAIRCHILD DOES NOT ASSUME ANY LIABILITY ARISING OUT OF THE APPLICATION OR USE OF ANY PRODUCT OR CIRCUIT DESCRIBED HEREIN; NEITHER DOES IT CONVEY ANY LICENSE UNDER ITS PATENT RIGHTS, NOR THE RIGHTS OF OTHERS.

LIFE SUPPORT POLICY

FAIRCHILD'S PRODUCTS ARE NOT AUTHORIZED FOR USE AS CRITICAL COMPONENTS IN LIFE SUPPORT DEVICES OR SYSTEMS WITHOUT THE EXPRESS WRITTEN APPROVAL OF THE PRESIDENT OF FAIRCHILD SEMICONDUCTOR CORPORATION. As used herein:

1. Life support devices or systems are devices or systems which, (a) are intended for surgical implant into the body, or (b) support or sustain life, and (c) whose failure to perform when properly used in accordance with instructions for use provided in the labeling, can be reasonably expected to result in a significant injury of the user.
2. A critical component in any component of a life support device or system whose failure to perform can be reasonably expected to cause the failure of the life support device or system, or to affect its safety or effectiveness.